

Article number: 20343632M863KS

Description: E+G levelling foot
GN 343.6-32-M8-63-KS

Measures

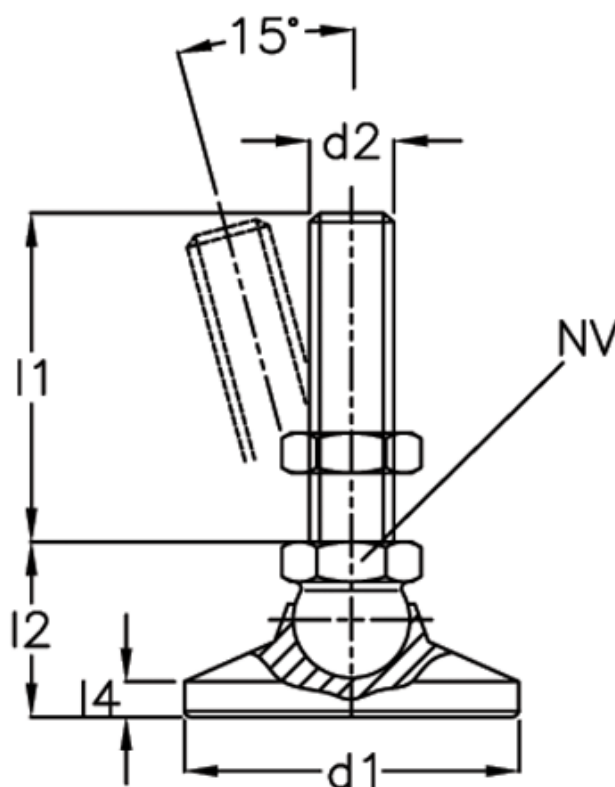

A/F	= 12
d1	= 32
d2	= 8
l1	= 63
l2	= -
l4	= -
Static load (N)	= 7
Weight in (g)	= 67